

UW339

EUROPAN 17
MUNICH
WHYNOT
30.07.23, 23:36H

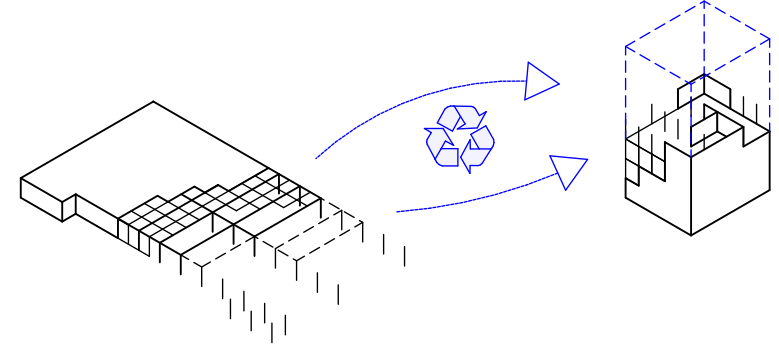

- existing trees
- new trees
- green areas
- greenhouse areas
- ▨ green roofs and photovoltaic

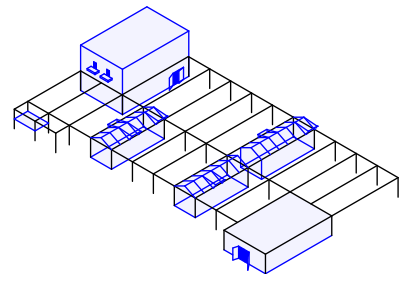
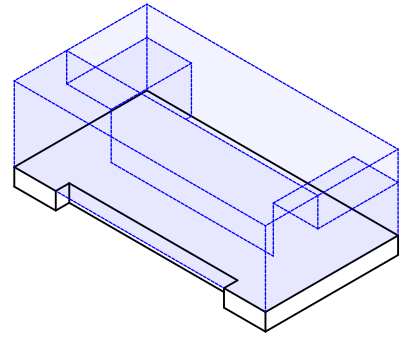
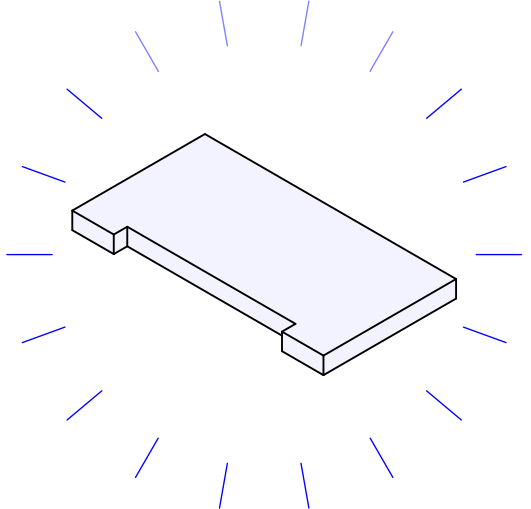

- roads
- parking garages
- delivery zones

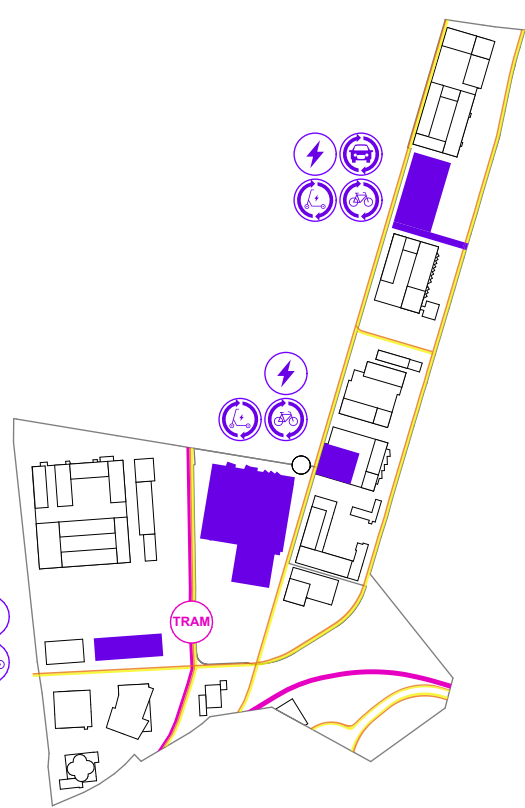

- bicycle lanes
- pedestrian lanes
- Mobility Hub
- carsharing
- E-scooter
- charging areas
- bikesharing
- cargo bikes
- rail transport
- tram station
- bus stop

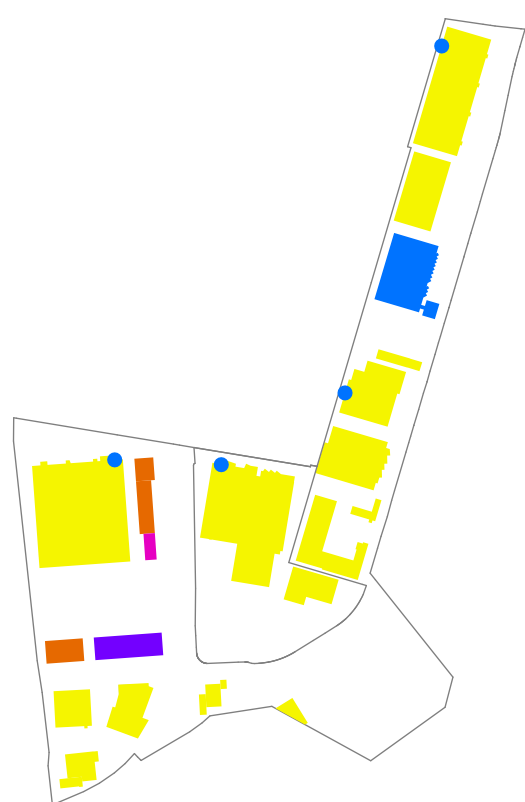

- mobility
- trade and production
- administration and urban infrastructure
- mixed used office space
- mixed use living space

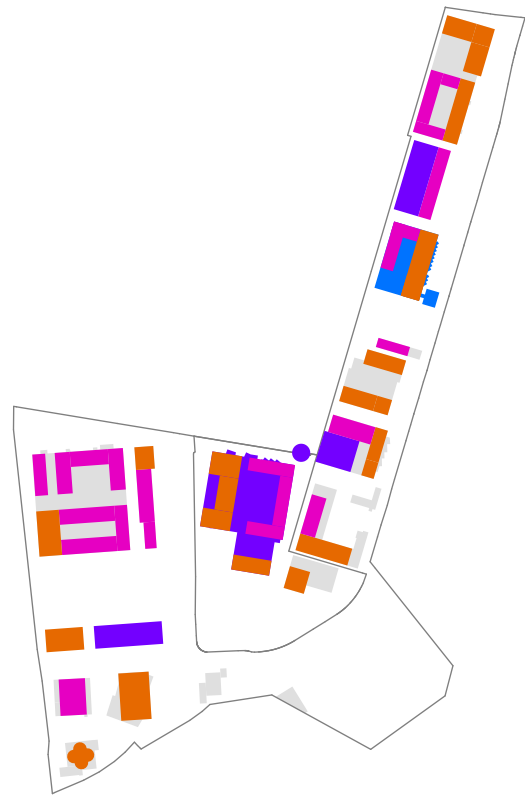

- mobility
- trade and production
- administration and urban infrastructure
- mixed used office space
- mixed use living space

